

# iArmor®

## iArmor® by APS

PART#: IA-S196H

### BEFORE INSTALLATION

REMOVE CONTENTS FROM BOX. VERIFY ALL PARTS ARE PRESENT. READ INSTRUCTIONS CAREFULLY BEFORE STARTING INSTALLATION. ASSISTANCE IS RECOMMENDED. THANK YOU FOR CHOOSING OUR PRODUCT!

\*ROCKER PANEL MOUNT

\*TRIMMING MAYBE REQUIRED

### Torque Value

Fastener Size	Tightening Torque (ft-lbs)	Required
6mm	6-7	X
8mm	16-18	√
10mm	31-32	X
12mm	56-58	X
14mm	92-94	X

### PART LIST

#### Driver Side Step Bar

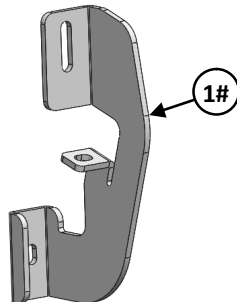
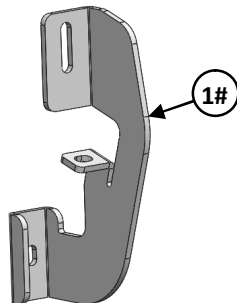
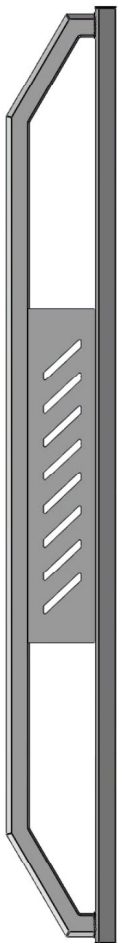

#### Front



#### Passenger Side Step Bar

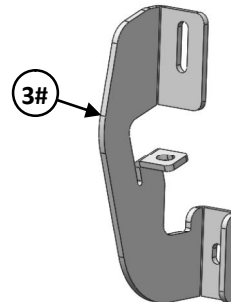
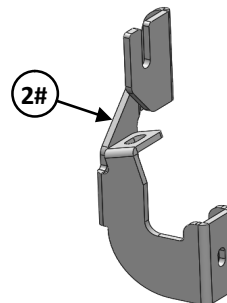
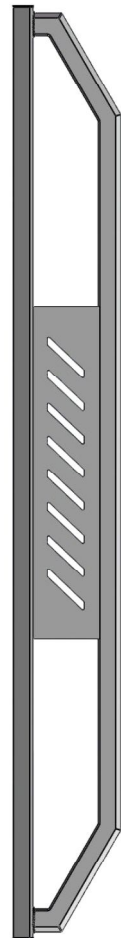

# iArmor®

Hardware Package A (For Bracket Installation)					
Item	QTY	Description	Item	QTY	Description
1#	2	Driver Front / Rear Mounting Brackets	5#	8	M8X1.25-25mm Hex Bolts
2#	1	Passenger Front Mounting Bracket	6#	8	M8 Large Flat Washers
3#	1	Passenger Rear Mounting Bracket	7#	8	M8 Lock Washers
4#	4	U Brackets	8#	8	M8 Clip Nuts

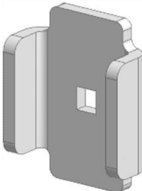

4 #



5 #



6 #



7 #

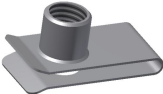

8 #

Hardware Package B (For Step Bar Installation)					
Item	QTY	Description	Item	QTY	Description
1#	4	M8X1.25-55mm Carriage Bolts	3#	4	M8 Lock Washers
2#	4	M8 Large Flat Washers	4#	4	M8 Hex Nuts

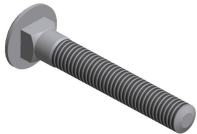

1 #



2#



3 #



4 #

# iArmor®

The instruction here is for your reference only. We strongly recommend the professional installer for best result. We are not responsible for any damage caused by the installation.

## STEP 1

Start the installation from the driver side of the vehicle. Locate the mounting tabs along the bottom edge of the body, (pinch weld). Mounting brackets will bolt to both mounting tabs. Directly above each tab is a top mounting location on the side of the body panel. (Fig 1).

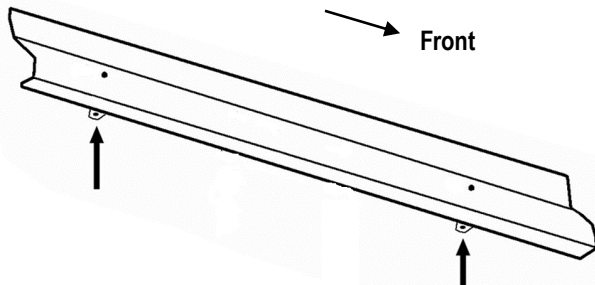

(Fig 1) Driver Side Mounting Locations

## STEP 2

Determine the correct procedure for your model year and each Bracket location.

### A. Bottom mounting location on the edge of the pinch weld

a) **Flat tab on pinch weld with factory installed weld nut:** Thread the M8X1.25-25mm Hex Bolt into weld nut from the backside down to clear paint from threads, (Fig 2).

b) **Flat tab on pinch weld with hole (Figs 3 & 4) :**

Select (1) M8 Clip Nut. Slide the Clip Nut over the tab with the nut facing up behind the tab. Repeat this **Step** for Driver Rear mounting location.

### B. Top mounting location on the back side of the body panel:

a) **Models with factory installed threaded insert in body panel:** Thread M8X1.25-25mm Hex Bolt into threaded insert to clear paint as required, (Fig 2).

b) **Models with large and small holes on the body panel (Fig 3,4):**

Remove the rubber plug from the larger hole. Select (1) M8

Clip Nut. Insert the Clip Nut into the larger hole with the threads facing in.

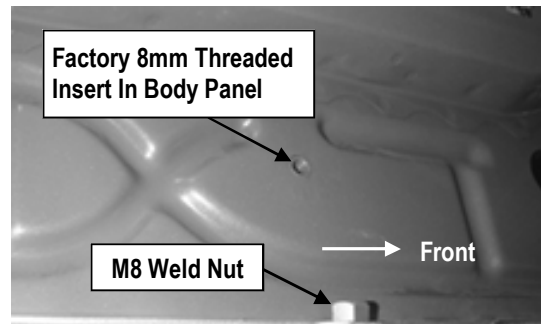

(Fig 2) Driver Front Mounting Bracket Location

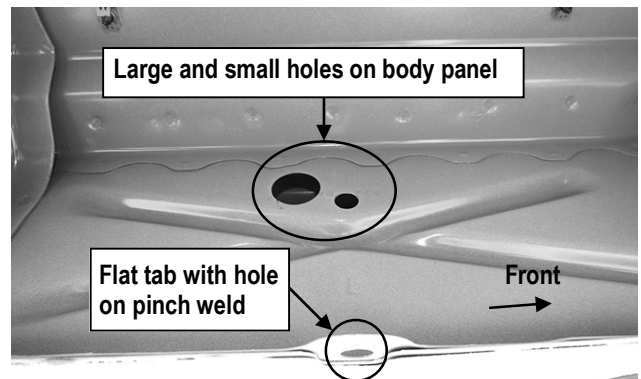

(Fig 3) Driver Side Front Mounting Location  
(Flat tab on Pinch Weld with hole)

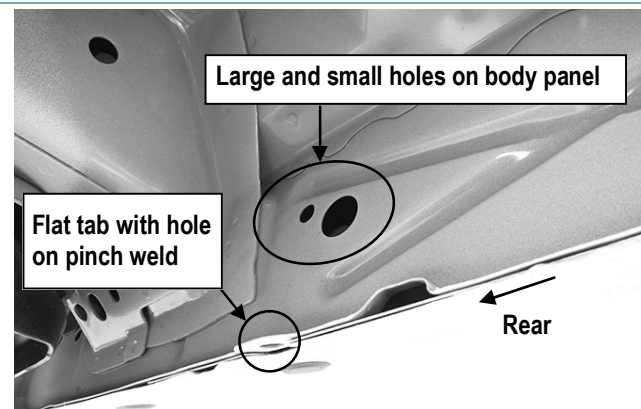

(Fig 4) Driver Side Rear Mounting Location  
(Flat tab on Pinch Weld with hole)

# iArmor<sup>®</sup>

## STEP 3

Select (1) Driver Front Mounting Bracket. Attach the bracket to the driver side front mounting location with (2) M8x1.25- 25mm Hex Bolts, (2) M8 Lock Washers and (2) M8 Flat Washers, (Fig 5). Do not fully tighten hardware at this time.

## STEP 4

Repeat **Step 3** to install the Driver Rear Mounting Bracket. Do not fully tighten hardware at this time.

## STEP 5

Once all (2) driver side mounting brackets are installed, select and attach the Driver Side Step Bar onto the Mounting Brackets with (2) U Brackets, (2) M8X1.25-55mm Carriage Bolts, (2) M8 Large Flat Washers, (2) M8 Lock Washers and (2) M8X1.25 Hex Nuts, (Fig 6). Properly level and adjust the Step Bar and fully tighten all hardware.

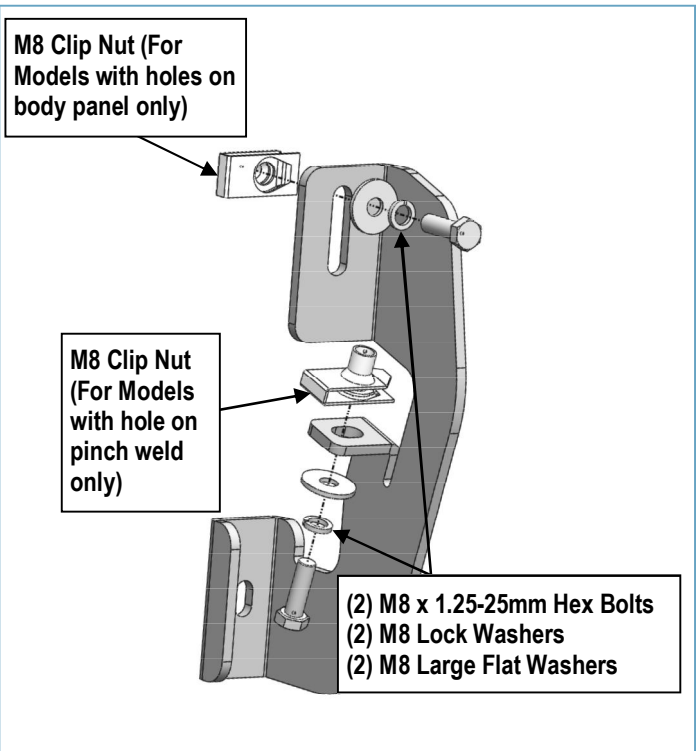

(Fig 5) Driver Front Mounting Bracket Installation

**NOTE:** Torque all M8 X1.25-55mm Carriage Bolts to 16~18 lb-ft. Don't over tighten, or the square bars will be damaged by the brackets

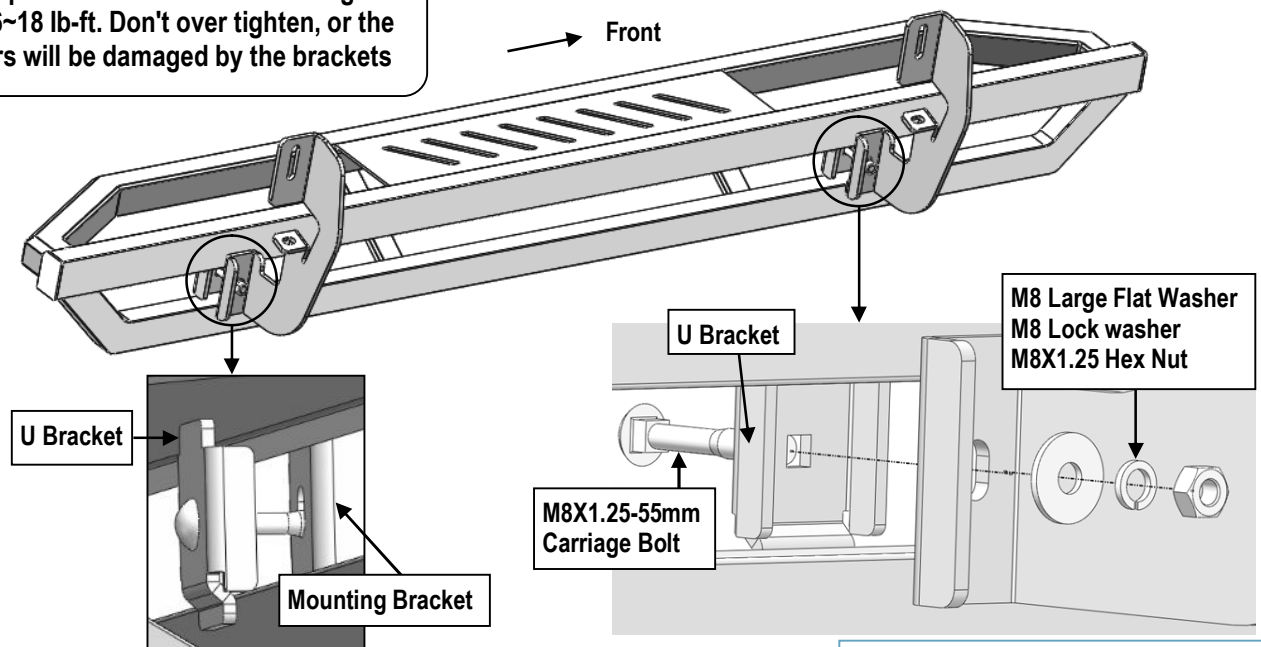

(Fig 6) Driver Side Step Bar Installation

## STEP 6

Move to the passenger side of the vehicle. On the Passenger side, determine if the vehicle is equipped with a plastic diesel exhaust fluid (DEF) tank, (Figs 7 & 8).

**Models without DEF tank, skip to Step 7.**

**Models with DEF tank, first determine correct procedure for your model year:**

• **2007-2016 Models with DEF tank:**

The tank sits close to the side of the body. With specialized tools, the Passenger Front Mounting Bracket can be installed but room is limited. It may be easier to drop the tank down to access the inner side of the body panel to mount the bracket. Tank will not need to be removed, only dropped down for access to mounting location.

**IMPORTANT:** If tank is full, it will be very heavy, and assistance is highly recommended to avoid injury or damage to the vehicle or the tank. It is recommended that installation is performed when the DEF tank is low on fluid before dropping the tank.

a. On models with plastic lower tray under the tank, remove the (3) hex bolts attaching the tray to the frame, (Fig 7), and remove the tray.

b. Release the tank filler hose. Release the plug for the sending unit on the top of the tank.

c. Support the tank with a floor jack. Place a smooth flat surface, (wooden block for example), between the floor jack and the tank to avoid damaging the plastic tank. Do not push up on the tank; only support the weight of the tank with the jack.

d. Remove the (2) bolts securing the tank straps to the vehicle, (Fig 8). Tilt the straps to release from the brackets. Slowly lower the tank until the top of the tank is almost visible. Use blocks or stands to support the tank while installing the Passenger Front Mounting Bracket.

e. Proceed to **Step 7**

• **2017-on 2500/3500 models:**

Do not remove the tank. Remove the (4) hex bolts attaching the plastic cover to DEF tank, (Fig 9A) and remove only the plastic cover, (Fig 9B).

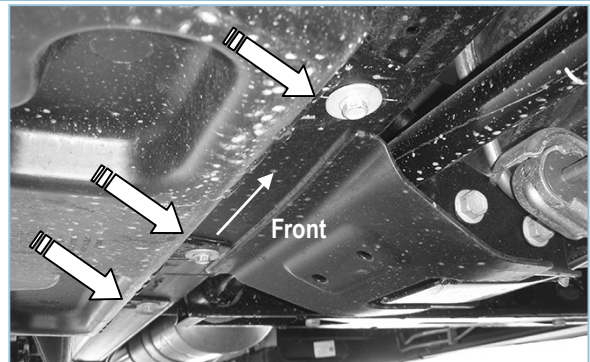

(Fig 7) 07-16 Passenger/Right front pictured with DEF tank cover. Remove (3) hex bolts to remove cover

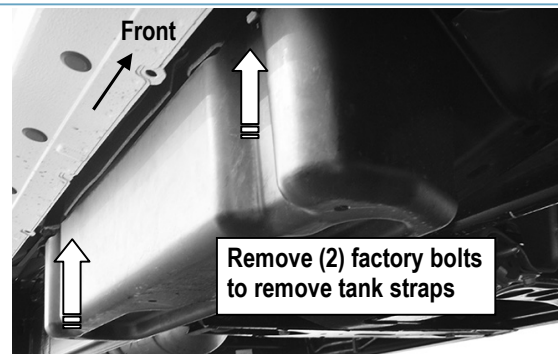

(Fig 8) Passenger side 07-16 DEF tank and cover

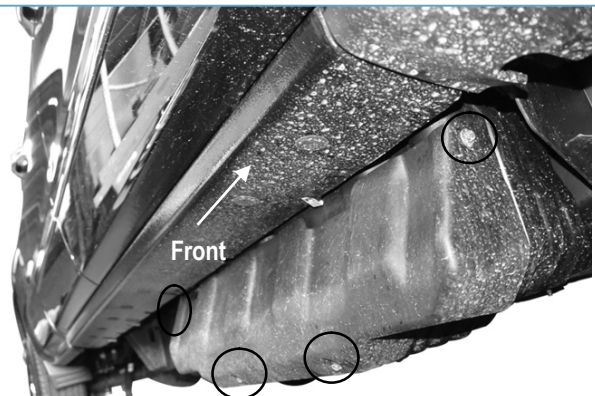

(Fig 9A) 17-on Passenger side pictured with DEF plastic tank cover. Remove (4) hex bolts to remove plastic cover



(Fig 9B) 17-on Passenger side DEF cover removed

# iArmor®

## STEP 7

Locate the front tab on the edge of the pinch weld on the Passenger/Right side. Repeat **Step 2** to attach the M8 Clip Nuts to the body panel.

Select the Passenger Front Mounting Bracket. Secure the mounting bracket to the body panel and pinch weld, (**Fig 10**).

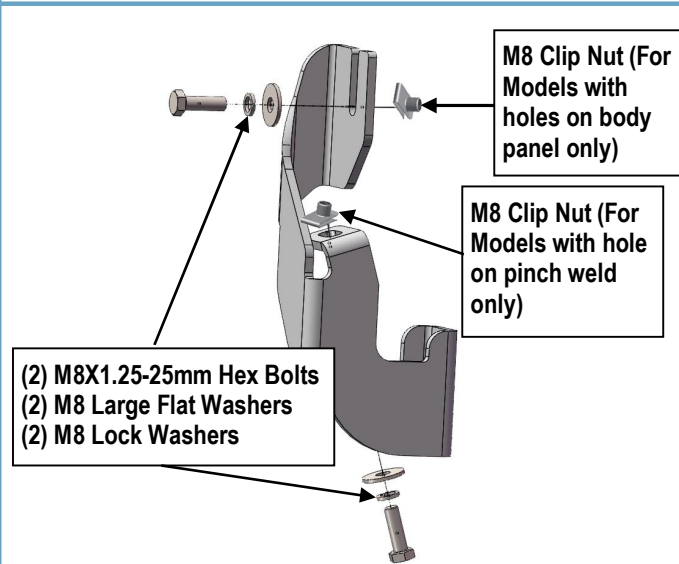

(Fig 10) Passenger Front Mounting Bracket Installation

## STEP 8

Repeat **Steps 2-3** for the remaining Passenger Rear Mounting Bracket installation.

**2017-up 2500/3500 DEF tank models:** Locate the 2nd tab bracket location along the bottom edge of the body, (pinch weld), (**Fig 11**). Hold the DEF cover in place and mark the 2nd Bracket location onto the cover, (**Fig 12**). Use a sharp knife or hacksaw blade to carefully cut a slot in the plastic cover to clear the 2nd Bracket, (**Fig 13**). Remove as little plastic as possible.

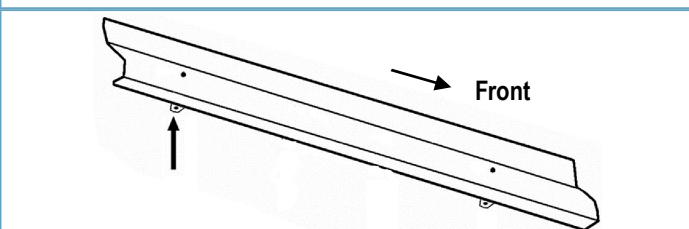

(Fig 11) Passenger Side Rear Mounting Location

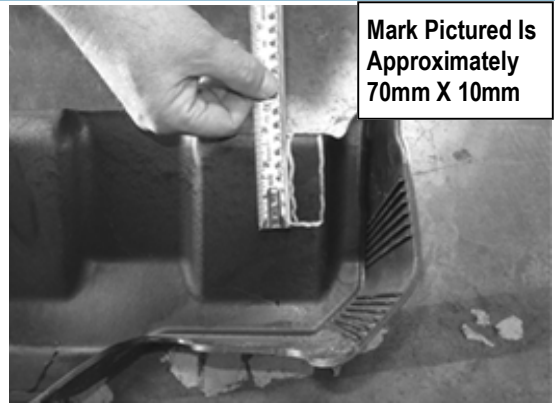

(Fig 12) 2017-Up Passenger Side DEF Cover Marked For Trimming

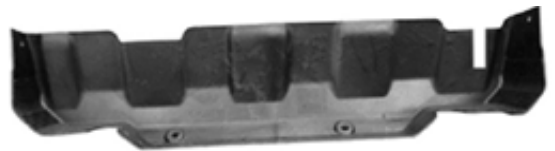

(Fig 13) 17-Up Passenger Side DEF Cut For Example Only

## STEP 9

Repeat **Step 5** to install the passenger side Running Board installation

## STEP 10

Once the Running Board are installed and all hardware fully tightened, reinstall the DEF tank and cover, if equipped, as described in **Step 6**.

The installation is completed.

### Attention

Do periodic inspections to the installation to make sure that all hardware is secure and tight.

In order to protect your bars/boards, please use mild soap/non-abrasive products for cleaning only.