



Hitch Installation Instruction

REV.20240401

Part#	HT-R30073	Application	For 2011-2013 Kia Sorento \2010-2012 Hyundai Santa Fe					
-------	-----------	-------------	-------------------------------------------------------	--	--	--	--	--

Hardware List	Item	Part Name	QTY	Description	Item	Part Name	QTY	Description
	1	Hex Bolts	4	M10X1.25-30	3	Hex Bolts	2	M10X1.5-120
	2	Conical Washers	6	M10	4	Hex Flange Nuts	2	M10X1.5

Gross Load Capacity When Used As A Weight Carrying Hitch: 3500 LBS. Trailer Weight & 350 LBS. Tongue Weight.
*****DO NOT EXCEED VEHICLE MANUFACTURER'S RECOMMENDED TOWING CAPACITY.*****

- * Trimming Required
- * No Drilling Required

WELDNUT CLEANING

To remove debris from weldnuts in frame, spray lubricant or compressed air into hole. For heavy debris, use a small wire brush. (Be careful not to damage threads).

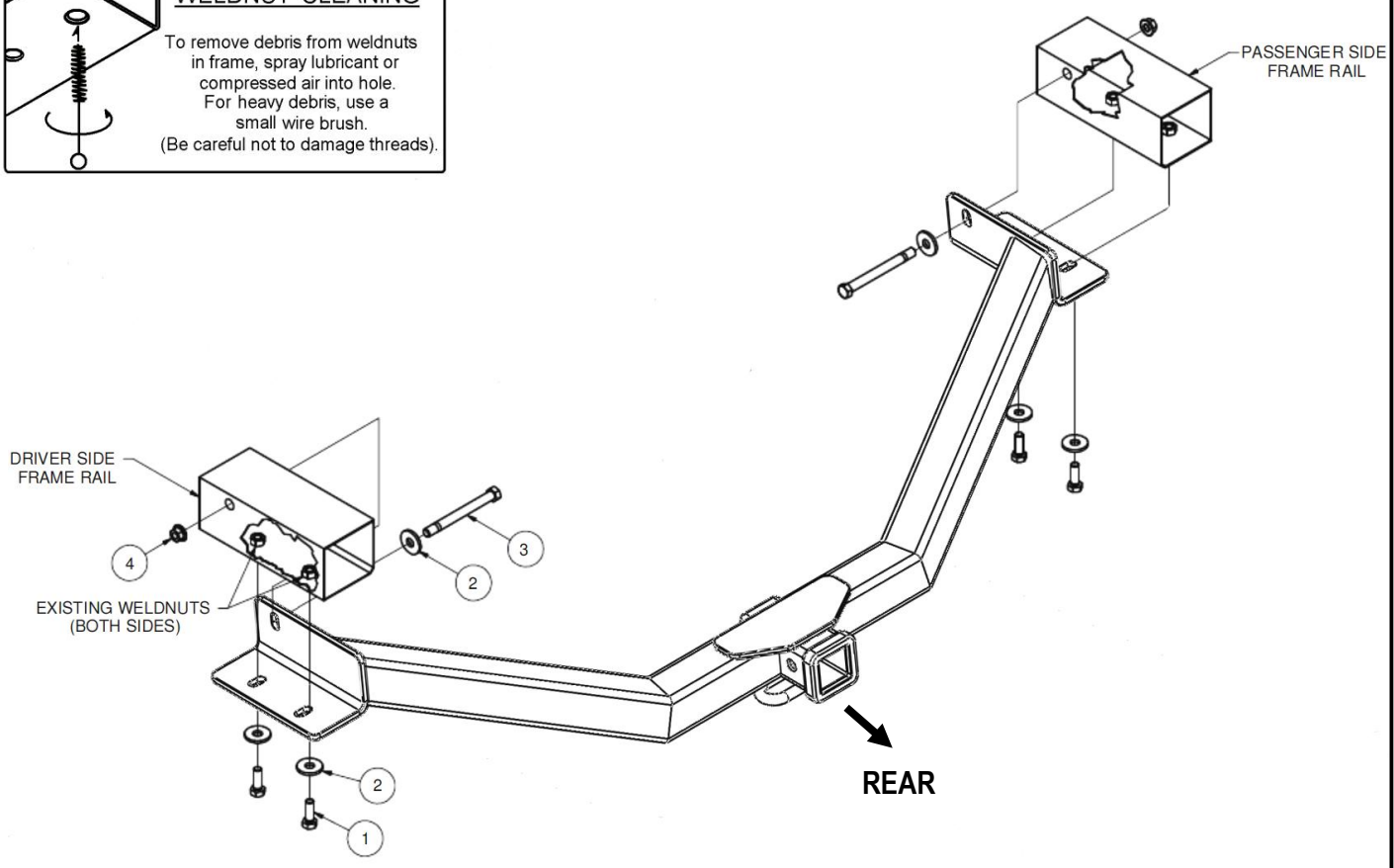



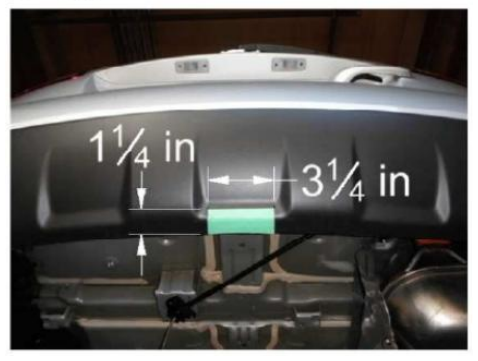





TRIM DIAGRAM (SOME MODELS)
 NOTE: Trimming is required on some models. Trim dimensions are approximate and may vary depending on vehicle model. Check fit prior to trimming.



The instruction here is for your reference only. We strongly recommend the professional installer for best result. We are not responsible for any damage caused by the installation. Thank you for choosing our product!





Hitch Installation Instruction

Part#	HT-R30073	Application	For 2011-2013 Kia Sorento \2010-2012 Hyundai Santa Fe
Step	Description		
1	Lower exhaust by removing (3) rubber isolators. To ease installation, lower and remove spare tire temporarily.		
			
2	Remove heat shield by removing (3) nuts and (1) screw. Trim heat shield to allow hitch side plate to rest against vehicle frame rail. The area trimmed off will remove approximately 8 inches of the heat shield that was along the inside of the frame rail.		
			
3	Reattach heat shield with (3) nuts from Step 2.		
			
4	Raise hitch into position by raising passenger side of hitch over exhaust and secure into position with supplied M10 Hex bolts and M10 conical washers, as shown. NOTE: If the vehicle fascia prevents the hitch from being raised completely into position see trim diagram on page 1.		
			

The instruction here is for your reference only. We strongly recommend the professional installer for best result. We are not responsible for any damage caused by the installation. Thank you for choosing our product!



Hitch Installation Instruction

Part#	HT-R30073	Application	For 2011-2013 Kia Sorento \2010-2012 Hyundai Santa Fe
5	Install M10 hardware through side plates and through pass through holes in frame rails as shown.		
			
6	Torque M10 hardware to 47 lb-ft. Raise exhaust and spare tire back into position.		
 			
<p>***Periodically Check The Receiver Hitch To Ensure That All Fasteners *** Are Tight & All Structural Components Are Sound.</p>			

The instruction here is for your reference only. We strongly recommend the professional installer for best result. We are not responsible for any damage caused by the installation. Thank you for choosing our product!