



Hitch Installation Instruction

REV.20240101

Part#	HT-R30206	Application	For 2014-2019 Subaru Outback
--------------	-----------	--------------------	------------------------------

Hardware List	Item	Part Name	QTY	Description	Item	Part Name	QTY	Description
	1#	Carriage Bolts	4	M12X1.75-40	3#	Hex Flange Nuts	4	
2#	Square Spacers	4	M12X1.75	4#	Fishwire	2		

Gross Load Capacity When Used As A Weight Carrying Hitch:4000 LBS. Trailer Weight & 600 LBS. Tongue Weight.
*****DO NOT EXCEED VEHICLE MANUFACTURER'S RECOMMENDED TOWING CAPACITY.*****

Drilling Required
Trimming Required

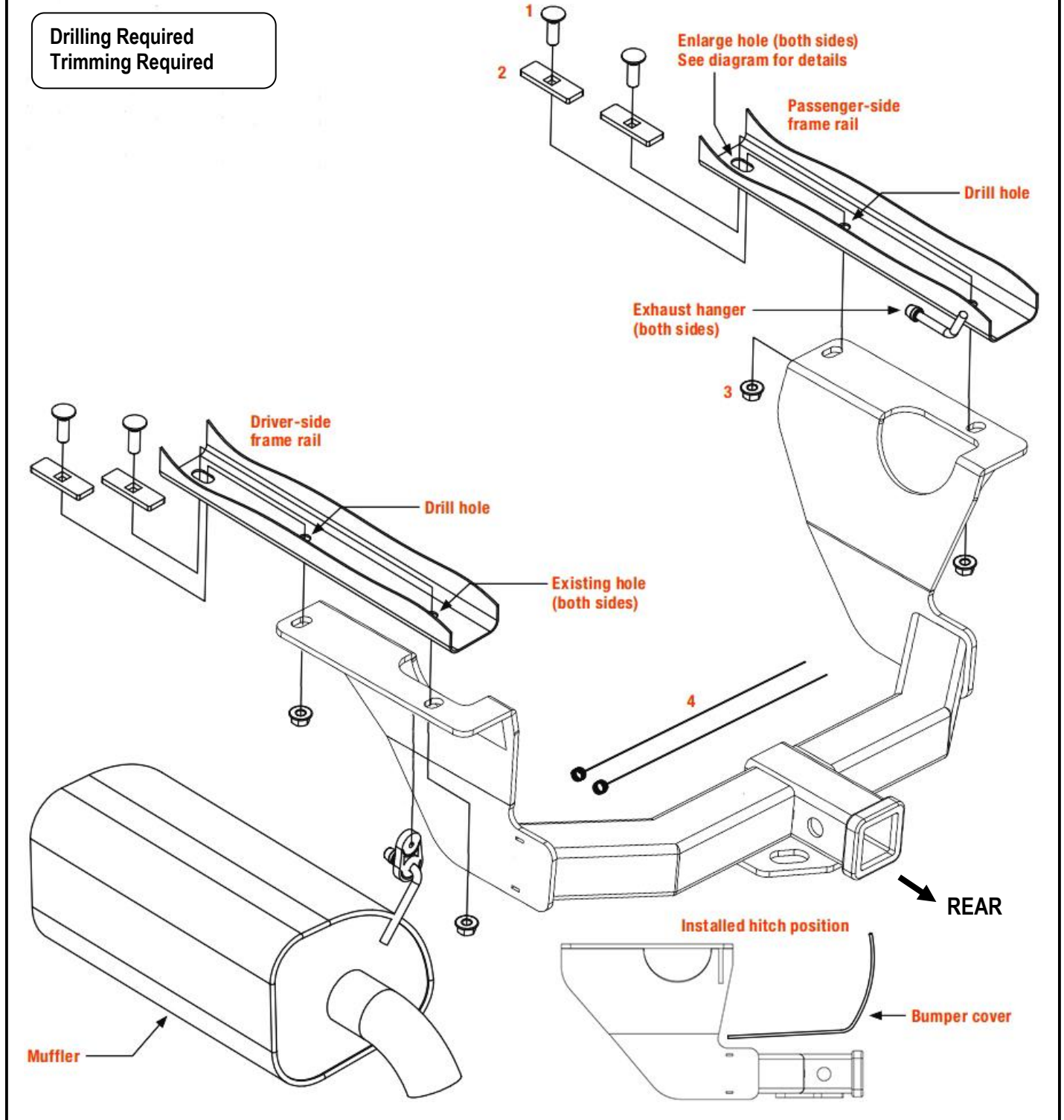







The instruction here is for your reference only. We strongly recommend the professional installer for best result. We are not responsible for any damage caused by the installation. Thank you for choosing our product!

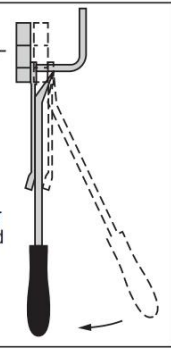

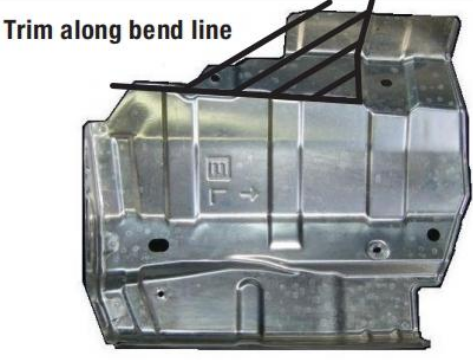
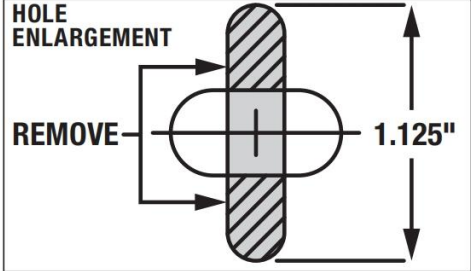
Hitch Installation Instruction

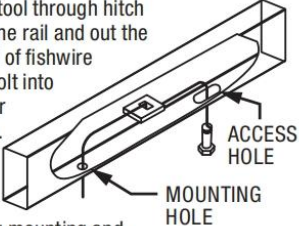
REV.20240101

Part#	HT-R30206	Application	For 2014-2019 Subaru Outback
Step	Description		
1	<p>Lower the exhaust by removing the three rearmost rubber exhaust isolators from the frame mounted hangers. Note: Support the exhaust during installation to prevent damage. See the "Rubber Isolator Removal Diagram".</p> <div data-bbox="336 360 826 707"> <p>RUBBER ISOLATOR REMOVAL DIAGRAM</p> <p>This technique can be used if exhaust hanger removal pliers are not available.</p> <p>Using a 5/8" open end wrench, slide the wrench up to the rubber isolator, cradling the hanger rod as shown.</p> <p>Place the flat edge of a pry bar between the wrench and the hanger stop or hanger rod. Then simply rotate the pry bar toward the wrench to remove the rubber isolator.</p> <p>Note: Using a lubricant or soapy water on the hanger rod and the rubber isolator helps removal.</p>  </div> 		
2	<p>Remove the muffler heat shield and trim it to clear the mounting plate as shown.</p> <div data-bbox="347 786 839 1137">  </div> <div data-bbox="863 779 1337 1137"> <p>Trim along bend line</p>  </div>		
3	<p>Remove the two rubber plugs in each frame rail. Enlarge the forward most hole on each frame rail to allow the provided M12 carriage bolt and square-hole spacer to be inserted into the frame rail. See "Hole Enlargement Diagram".</p> <div data-bbox="347 1234 820 1503"> <p>HOLE ENLARGEMENT</p>  <p>REMOVE</p> <p>1.125"</p> </div> 		
4	<p>Fishwire a M12 carriage bolt and square-hole spacer into the rearmost hole in each frame rail, as shown, leaving the fishwire attached. See "Fishwire Technique".</p> <div data-bbox="284 1671 847 1995"> <p>FISHWIRE TECHNIQUE</p> <p>Insert coiled end of fishwire tool through hitch mounting hole in vehicle frame rail and out the access hole. Pass coiled end of fishwire through spacer and thread bolt into coil. Kink wire to keep spacer separate from bolt as shown. Pull fishwire, spacer and bolt through frame and out mounting hole. Use fishwire to guide hitch during mounting and prevent loss of bolt or spacer inside frame rail.</p>  <p>ACCESS HOLE</p> <p>MOUNTING HOLE</p> </div> 		







The instruction here is for your reference only. We strongly recommend the professional installer for best result. We are not responsible for any damage caused by the installation. Thank you for choosing our product!



Hitch Installation Instruction

REV.20240101

Part#	HT-R30206	Application	For 2014-2019 Subaru Outback
--------------	-----------	--------------------	------------------------------

5	Raise the trailer hitch into position. Center the hitch on the vehicle, remove the fishwire, and loosely secure the hitch to the vehicle with the provided hex flange nuts.	
		
6	Mark and drill the forward most holes in the frame rail using the trailer hitch as your guide. Fishwire a M12 carriage bolt and square-hole spacer into each drilled hole and secure the hitch with a hex flange nut.	
		
7	Torque all M12 Fasteners to 86 lb-ft. Reinstall the heat shield, raise the exhaust back into position and reinstall the rubber isolaters.	
		

The instruction here is for your reference only. We strongly recommend the professional installer for best result. We are not responsible for any damage caused by the installation. Thank you for choosing our product!