



Hitch Installation Instruction

REV.20231201

Part#	HT-R30200	Application	For 2014-2019 Toyota Highlander					
--------------	-----------	--------------------	---------------------------------	--	--	--	--	--

Hardware List	Item	Part Name	QTY	Description	Item	Part Name	QTY	Description
	1	Hex Bolts	6	M12 X1.25-35	2	Conical Washer	6	M12

Gross Load Capacity When Used As A Weight Carrying Hitch: 6000 LBS. Trailer Weight & 900 LBS. Tongue Weight.
 Gross Load Capacity When Used As A Weight Distribution Hitch: 8000LBS. Trailer Weight & 900 LBS. Tongue Weight
*****DO NOT EXCEED VEHICLE MANUFACTURER'S RECOMMENDED TOWING CAPACITY.*****

WELDNUT CLEANING

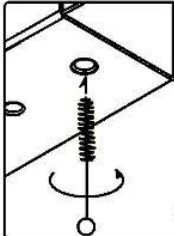

To remove debris from weldnuts in frame, spray lubricant or compressed air into hole. For heavy debris, use a small wire brush. (Be careful not to damage threads).

*** No Drilling Required**
*** Trimming Required**

CONICAL TOOTHED WASHER ORIENTATION DIAGRAM

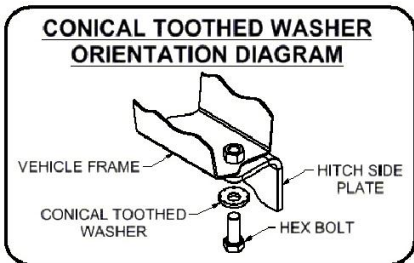



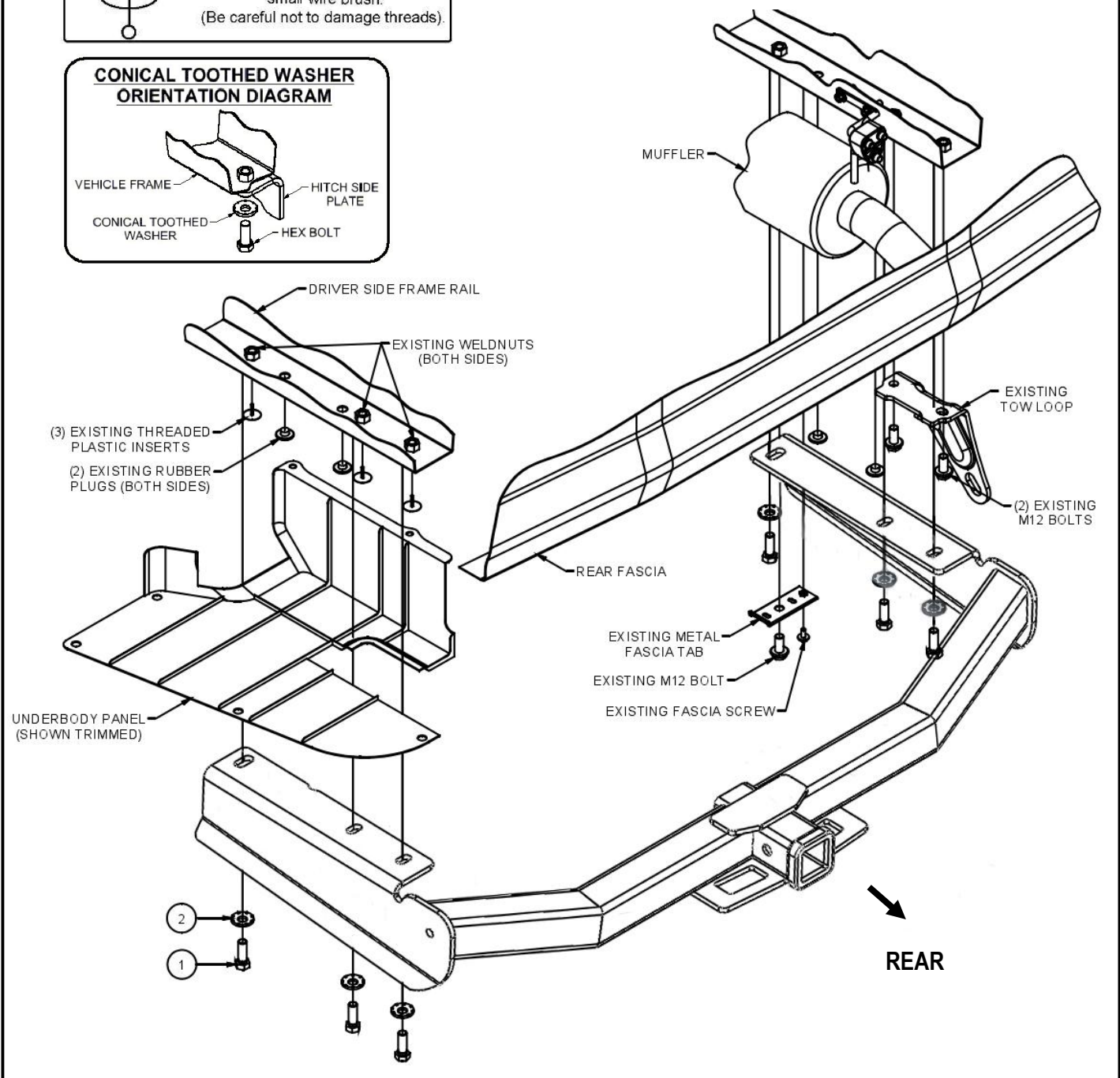

VEHICLE FRAME
 HITCH SIDE PLATE
 CONICAL TOOTHED WASHER
 HEX BOLT



The instruction here is for your reference only. We strongly recommend the professional installer for best result. We are not responsible for any damage caused by the installation. Thank you for choosing our product!



Hitch Installation Instruction

Part#	HT-R30200	Application	For 2014-2019 Toyota Highlander
Step	Description		
1	<p>Remove the (7) fasteners securing the driver side underbody panel. Keep the panel or trim and reinstall in Step 5.</p> 		
2	<p>Remove the (2) rubber plugs from the frame rails and unscrew the (3) threaded plastic inserts from the driver side frame rail. Return plugs and inserts to the owner. Mark the lower fascia exhaust air deflector 2" from the "hinge" and trim as shown above to allow room for the hitch.</p>  		
3	<p>Remove the (3) M12 bolts securing the metal fascia tab and tow loop to the passenger side frame rail. Remove the (1) fascia screw and metal fascia tab from the passenger side underbody panel..</p>  		

The instruction here is for your reference only. We strongly recommend the professional installer for best result. We are not responsible for any damage caused by the installation. Thank you for choosing our product!

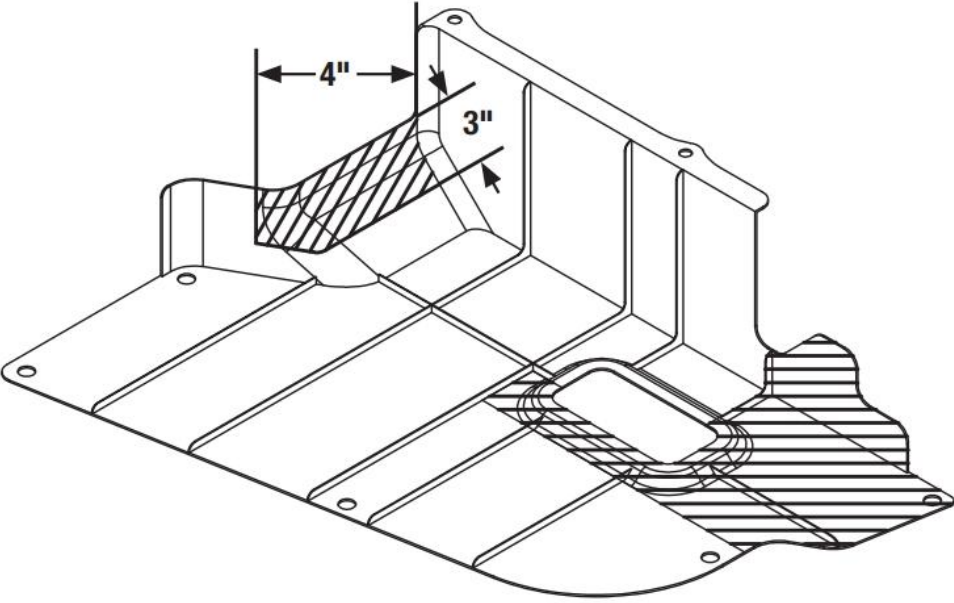

Hitch Installation Instruction

Part#	HT-R30200	Application	For 2014-2019 Toyota Highlander
4	<p>Raise the hitch over the exhaust and align the holes in the hitch with the weldnuts in the frame. Secure the hitch to the frame using the supplied M12X1.25 hex bolts and M12 conical toothed washers. Tighten all fasteners. Torque all M12 hardware to 86 ft-lbs.</p>		
			
5	<p>Mark and trim the underbody panel. See the trim diagram for reference. Dimensions are approximate. Confirm fit prior to trimming. Use the ribs of the underbody panel as cutting guides. Reattach the underbody panel using the fasteners removed in Step 1.</p>		
			
<p>***Periodically Check The Receiver Hitch To Ensure That All Fasteners *** Are Tight & All Structural Components Are Sound.</p>			

The instruction here is for your reference only. We strongly recommend the professional installer for best result. We are not responsible for any damage caused by the installation. Thank you for choosing our product!