

Part#	HT-R30127	Application	For 2013-2016 Mazda CX-5					
--------------	-----------	--------------------	--------------------------	--	--	--	--	--

Hardware List	Item	Part Name	QTY	Description	Item	Part Name	QTY	Description
	1#	Hex Flange Nuts	4	M12X1.75	3#	Fish wires	4	
2#	Carriage Bolts	4	M12X1.75-40	4#	Spacers	4	With SQ Hole	

Gross Load Capacity When Used As A Weight Carrying Hitch:3500 LBS. Trailer Weight & 525 LBS. Tongue Weight.
*****DO NOT EXCEED VEHICLE MANUFACTURER’S RECOMMENDED TOWING CAPACITY.*****

Drilling Not Required

RUBBER ISOLATOR REMOVAL DIAGRAM

This technique can be used if exhaust hanger removal pliers are not available.

Using a 5/8" open end wrench, slide the wrench up to the rubber isolator, cradling the hanger rod as shown.

Place the flat edge of a pry bar between the wrench and the hanger stop or hanger rod. Then simply rotate the pry bar toward the wrench to remove the rubber isolator.

Note: Using a lubricant or soapy water on the hanger rod and the rubber isolator helps removal.

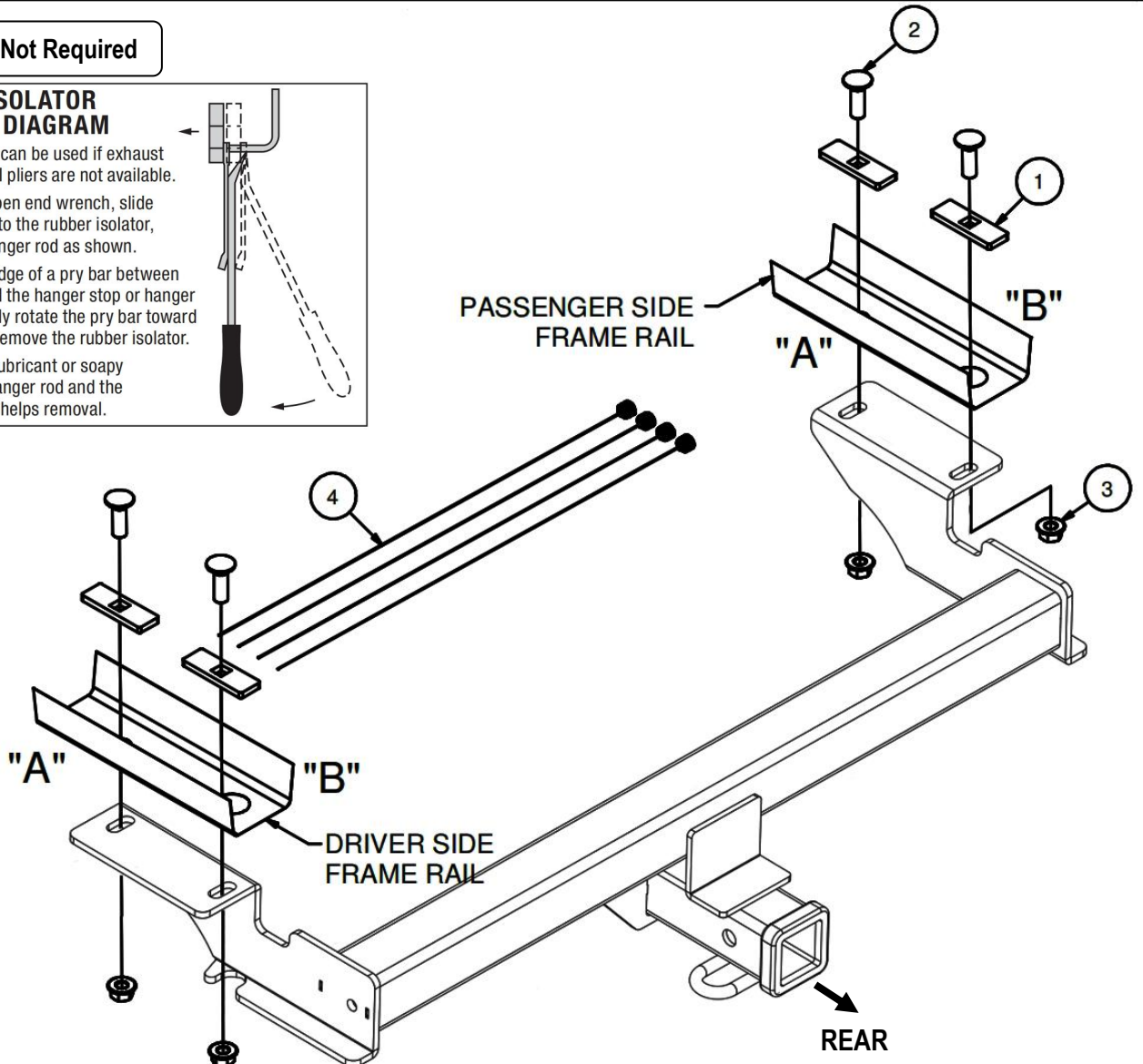
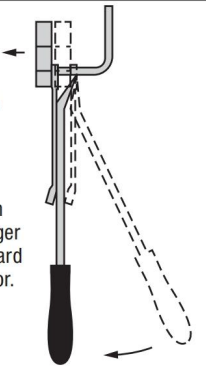

FISHWIRE TECHNIQUE

INSERT COILED END OF FISHWIRE TOOL THROUGH HITCH MOUNTING HOLE IN VEHICLE FRAME RAIL AND OUT THE ACCESS HOLE. PASS COILED END OF FISHWIRE THROUGH SPACER AND THREAD BOLT INTO COIL. KINK WIRE TO KEEP SPACER SEPARATE FROM BOLT AS SHOWN. PULL FISHWIRE, SPACER, AND BOLT THROUGH FRAME AND OUT MOUNTING HOLE. USE FISHWIRE TO GUIDE HITCH DURING MOUNTING AND PREVENT LOSS OF BOLT / SPACER INSIDE FRAME RAIL.

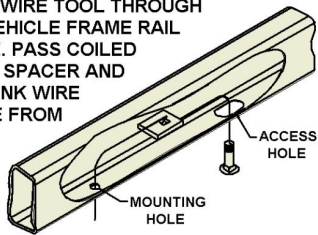



****NOTE: SOME VEHICLES MAY FISHWIRE THROUGH END OF FRAME****

REVERSE PULL FISHWIRE TECHNIQUE

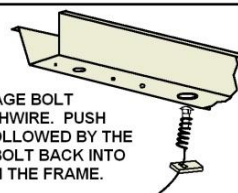
ATTACH FISHWIRE TO CARRIAGE BOLT AND SLIDE SPACER ONTO FISHWIRE. PUSH THE BOLT THRU THE HOLE FOLLOWED BY THE SPACER (AS SHOWN). PULL BOLT BACK INTO POSITION, PROTRUDING FROM THE FRAME.

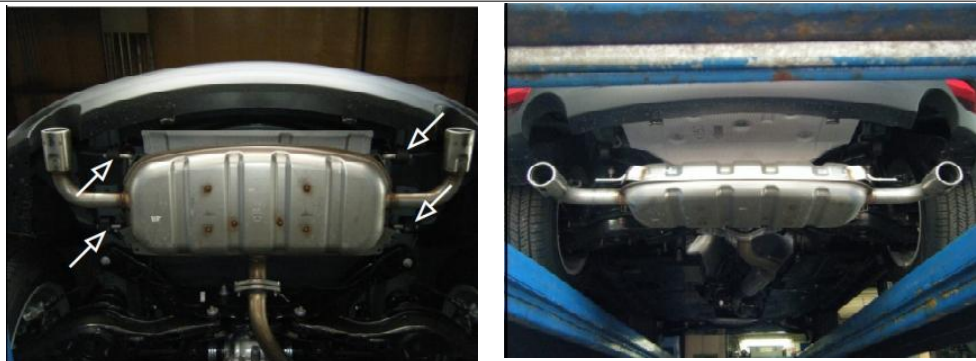
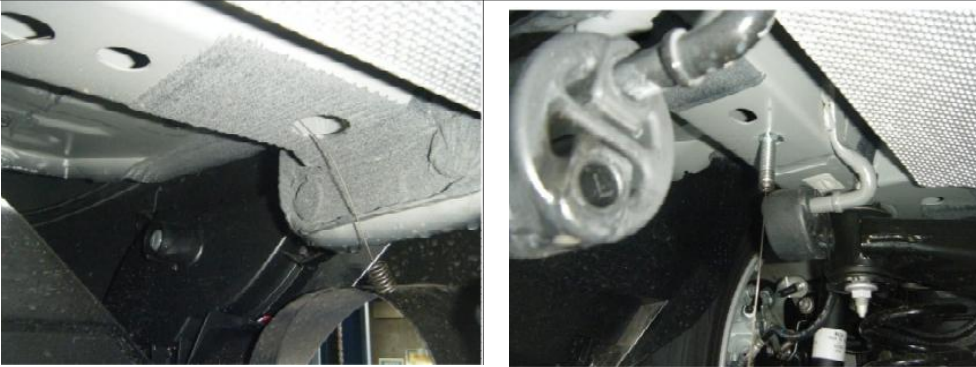
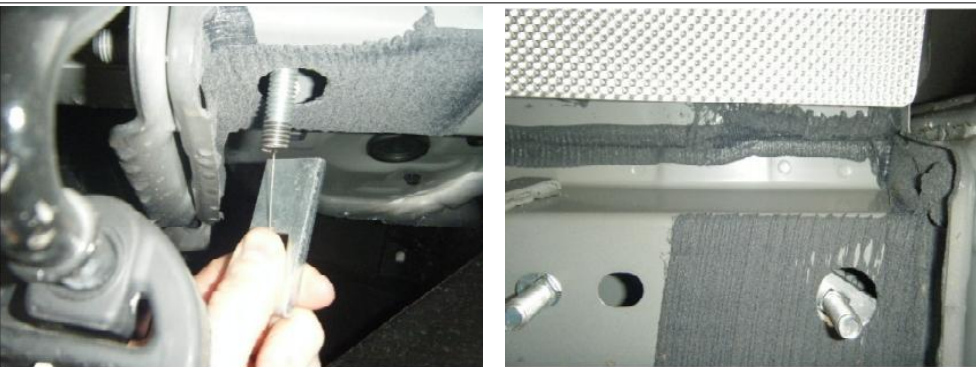

The instruction here is for your reference only. We strongly recommend the professional installer for best result. We are not responsible for any damage caused by the installation. Thank you for choosing our product!

Part#	HT-R30127	Application	For 2013-2016 Mazda CX-5
Step	Description		
1	<p>Lower the exhaust for ease of install.(Remove (4) rubber hangers to lower the exhaust.) NOTE: Use a spray lubricant or soapy water on the hanger rod and isolator to ease removal.)</p> 		
2	<p>Fishwire the M12 carriage bolts and spacers.</p> 		
3	<p>Reverse pull fishwire the M12 carriage bolts and spacers.</p> 		
4	<p>Raise the hitch into position and secure using the M12 hex flange nuts.</p> 		

The instruction here is for your reference only. We strongly recommend the professional installer for best result. We are not responsible for any damage caused by the installation. Thank you for choosing our product!

Part#	HT-R30127	Application	For 2013-2016 Mazda CX-5
5	<p>Torque all M12 fasteners to 86 lb-ft.</p> 		
6	<p>Reinstall the exhaust and the rubber isolators removed in Step 1. Installation complete.</p> 		

The instruction here is for your reference only. We strongly recommend the professional installer for best result. We are not responsible for any damage caused by the installation. Thank you for choosing our product!