

Part#	GR07HFC62T/U	Application	For 2016-2018 GMC Sierra 1500					
-------	--------------	-------------	--------------------------------------	--	--	--	--	--

Parts List	Item	Part Name	QTY	Description	Item	Part Name	QTY	Description
	1	Billet Grille	1	Aluminum	3	Flat Nut	8	
2	Screw	8	8#X1"					

Install Notes: Overlay Replacement Drill Cut

Step	Description	illustration
1	Identify the grille & hardware with parts list.	

2 Turn off engine and chalk tires with stop block. Open Hood. Disconnect Battery.

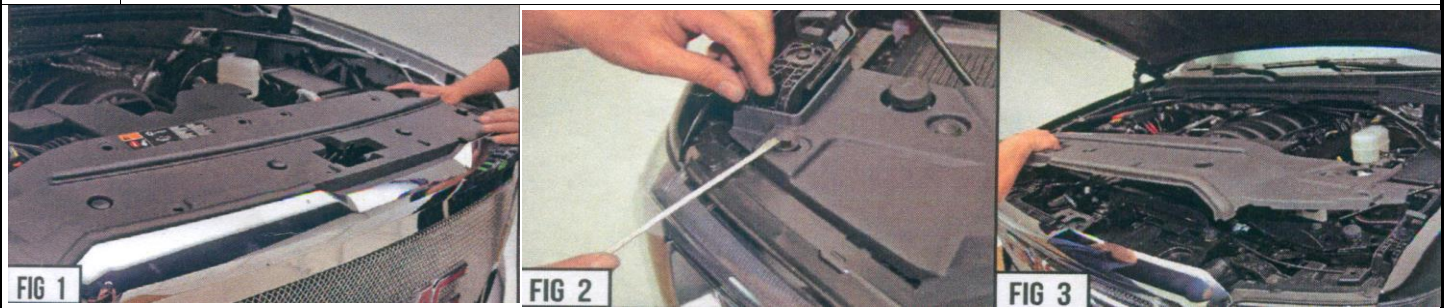

3 Begin by removing the plastic core support cover shroud. There will a number of plastic "Push Tabs" that secure the cover. Remove them all and aside for reinstallation. Remove cover and set aside for later.

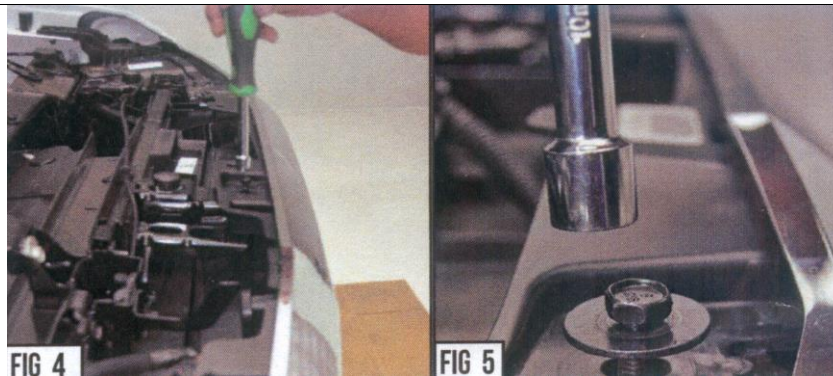

4 Remove the factory hardware that secures the grille assembly to the core support.

The instruction here is for your reference only. You may need to bend the grille a little bit to adjust to fit. We strongly recommend the professional installer for best result. We are not responsible for any damage caused by the installation. Thank you for choosing our product!

Part#	GR07HFC62T/U	Application	For 2016-2018 GMC Sierra 1500
-------	--------------	-------------	-------------------------------



5 It is now time to loosen the vehicle wheel well fender trim. Start at the top middle, and working your way towards the very front of the fender trim where it meets the front bumper, use a torq bit remove screws. With the front half fender trim loose and pulled out of the way, (as seen in Figure 7) you can access the additional hardware that secure the plastic lower bumper valance. Remove these bolts and set aside all hardware for re-installation later.

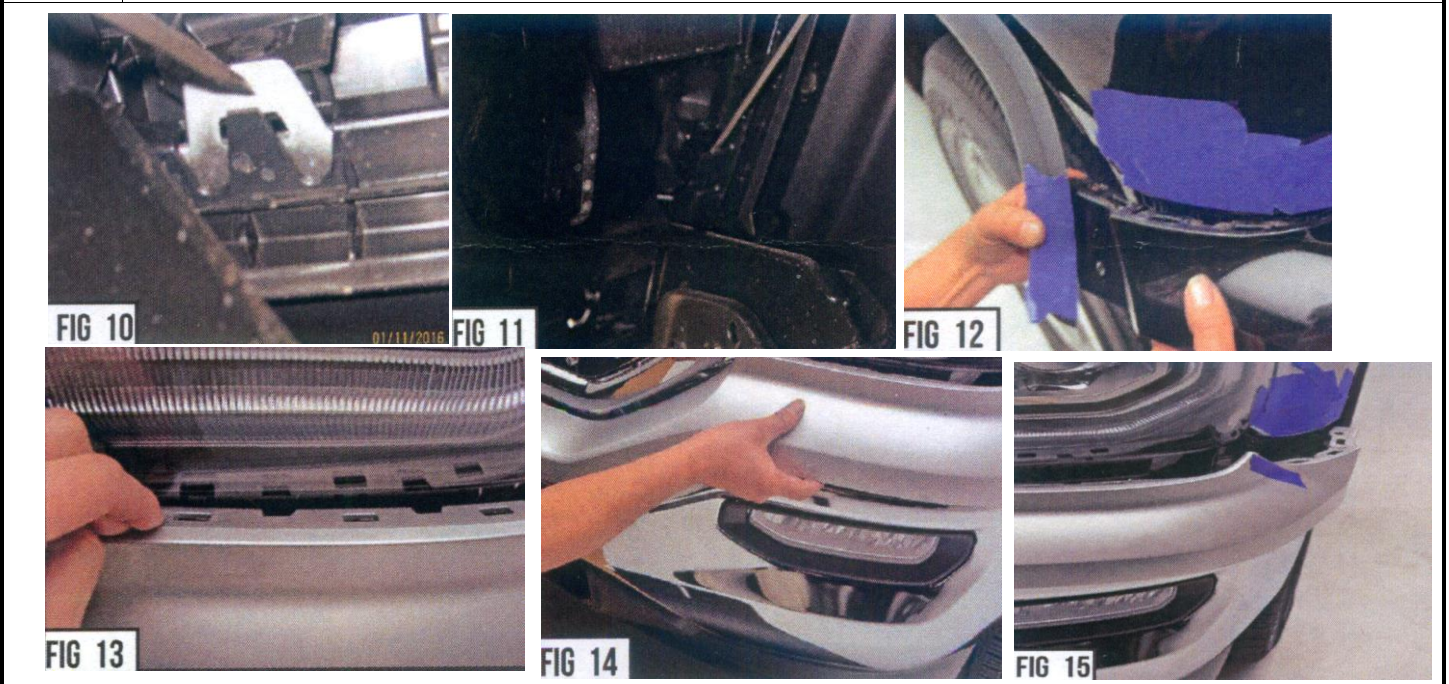

6 At this point, you need to remove the vehicles plastic lower bumper valance (a long and slim trim panel that is located directly above the front bumper, below the grille, and is usually color matched to the vehicle body color). Slip out the valance away from where it meets the front fender. You will need to unfasten several tabs that latch the whole piece from under and behind bumper and underneath headlights.

7 With the lower plastic bumper valance removed you can now access several bolts at the bottom below the grille lip and above the vehicle bumper and also located (2) more at the lower corners. Remove all hardware that fixes grilles assembly to vehicle.

The instruction here is for your reference only. You may need to bend the grille a little bit to adjust to fit. We strongly recommend the professional installer for best result. We are not responsible for any damage caused by the installation. Thank you for choosing our product!

Part#	GR07HFC62T/U	Application	For 2016-2018 GMC Sierra 1500
-------	--------------	-------------	--------------------------------------

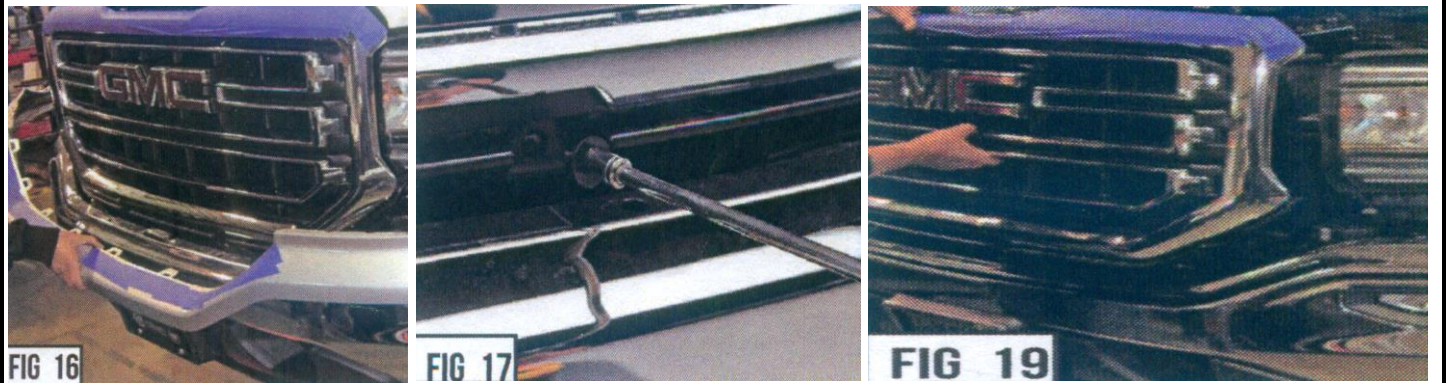

- | | |
|----|---|
| 8 | Using both hands, grab the very bottom corners of each side and firmly pull on both sides. This action will pull loose and release the grille assembly from the grille mounts. The grille should now be free to pull away from truck. |
| 9 | Flip the grille assembly over and place on a flat cushioned surface or foam pad to begin disassembly. |
| 10 | It is now time to remove the radiator induction shroud. Remove all the plastic push tabs that secures the shroud and set aside for later. |

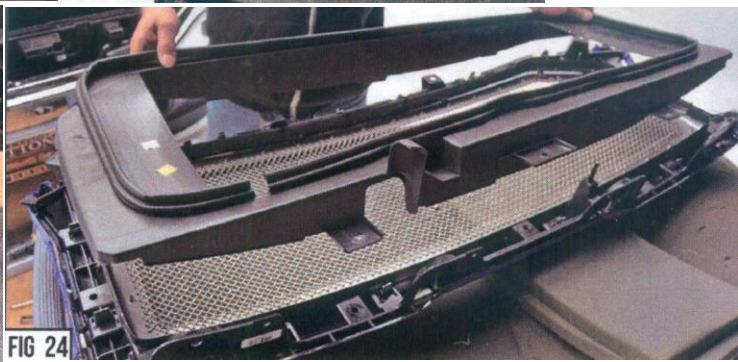
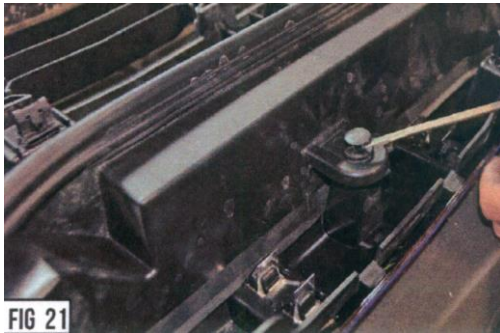

The instruction here is for your reference only. You may need to bend the grille a little bit to adjust to fit. We strongly recommend the professional installer for best result. We are not responsible for any damage caused by the installation. Thank you for choosing our product!

Part#	GR07HFC62T/U	Application	For 2016-2018 GMC Sierra 1500
-------	--------------	-------------	--------------------------------------

11 With the radiator shroud removed and safely out of the way. It is now time cut into the factory grille plastic pattern design and separate the factory grille shell to re-purpose and utilize with your new grille.
From the grilles backside, make a proper cutting path using a paint pen or bright marker to highlight the correct cutting patch along the outer edge of the plastic grille pattern.

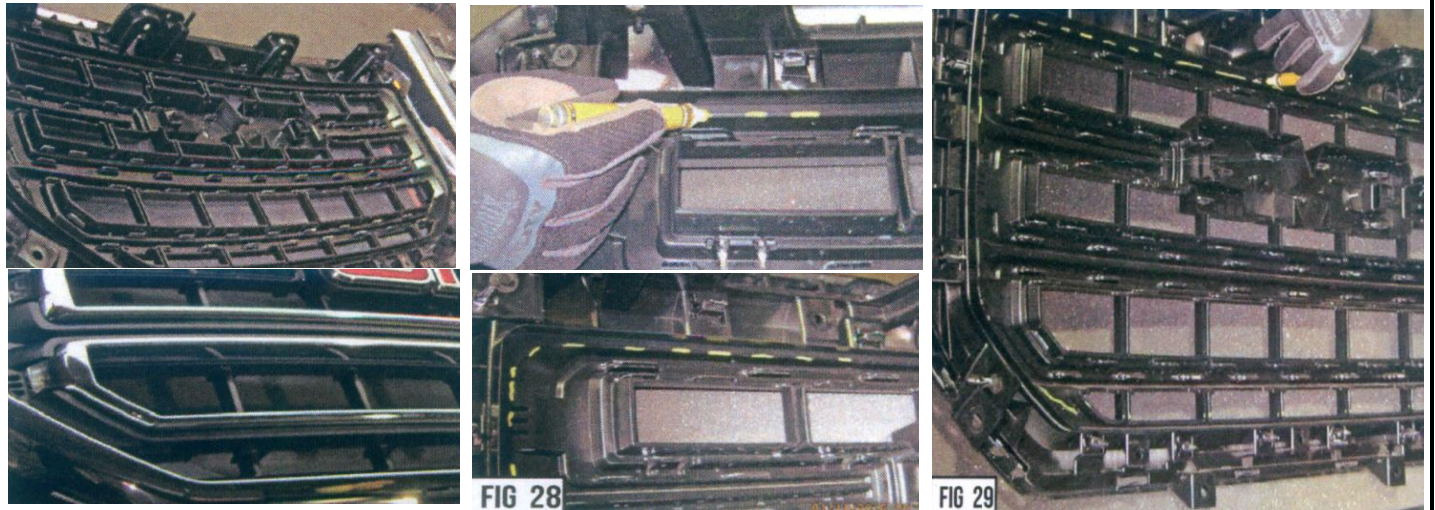

12 To gain familiarity it is recommended to examine the grille face and back side so that you understand where you will be cutting and where and how the new Grille will insert and mount to the factory grille shell.

13 Using Figures 28 & 29 as reference as proper cut locations around edge and corners, make one final confirmation that your cut line is well clear of the factory chrome shell. You DO NOT want to cut into or damage the chrome shell.

14 From the grilles backside, use a 90 degree cutoff wheel, zip saw, sawzall or something similar, carefully cut along your marked line.
Carefully navigate cutting your corner edges.
Carefully continue your cut path along outer edge without damaging factory.
At this point, check over your work and make certain your cut reflects the images presented here.



15 Separate the shell from the inner grille piece.

The instruction here is for your reference only. You may need to bend the grille a little bit to adjust to fit. We strongly recommend the professional installer for best result. We are not responsible for any damage caused by the installation. Thank you for choosing our product!

Part#	GR07HFC62T/U	Application	For 2016-2018 GMC Sierra 1500
-------	--------------	-------------	--------------------------------------

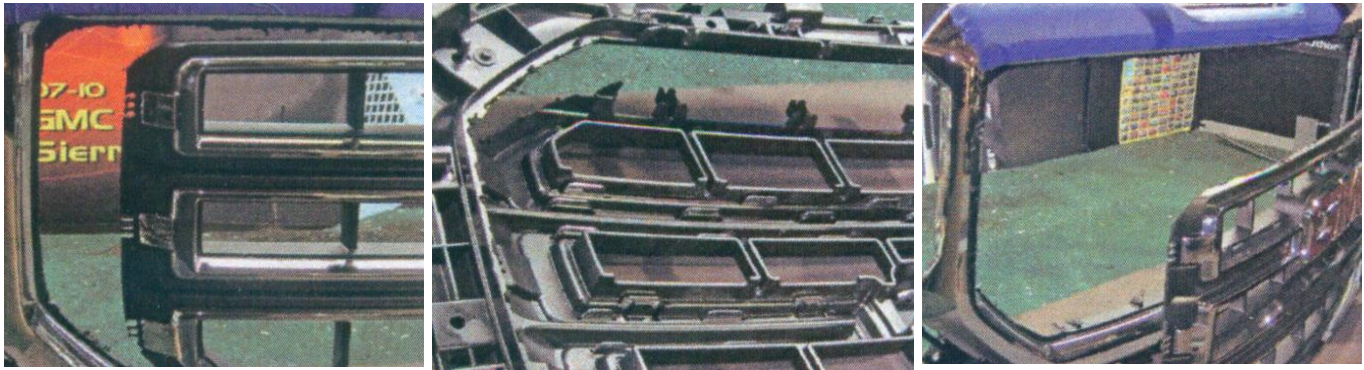

16 For those that do want to feature the GMC Badge, you will need to first remove it from the factory grille and set aside for later use.

17 Using a 90 degree sanding disc, sand paper, file, or something of the sort, clean up and sand down the plastic debris left over from the cut out grille piece



18 Carefully align the grille so that it sits evenly aligned with the shell and then clamp into place with vice grips or something similar. Once satisfied with the alignment and fitment and with the grille insert clamps in place, mark with a paint pen.



19 Flip over to inspect grille fitment of billet face alignment alongside grille shell and for proper sitting depth with shell. If adjustments are needed release clamps, and reset fitment till satisfied. At this point, you should examine and carefully look over your work. Inspect for proper alignment depth and fitment.

The instruction here is for your reference only. You may need to bend the grille a little bit to adjust to fit. We strongly recommend the professional installer for best result. We are not responsible for any damage caused by the installation. Thank you for choosing our product!

Part#	GR07HFC62T/U	Application	For 2016-2018 GMC Sierra 1500
-------	--------------	-------------	--------------------------------------

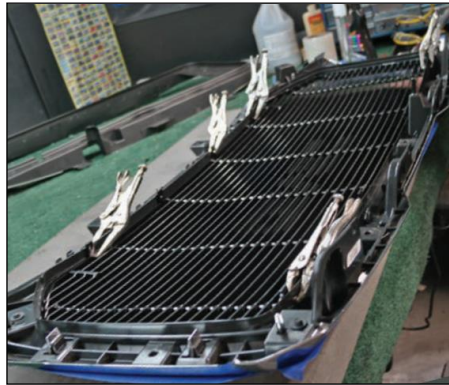

20

Once satisfied with the alignment and fitment and with the grille insert clamped in place, drill 1/8" hole for each of the pre-fixed grille mounting tabs.

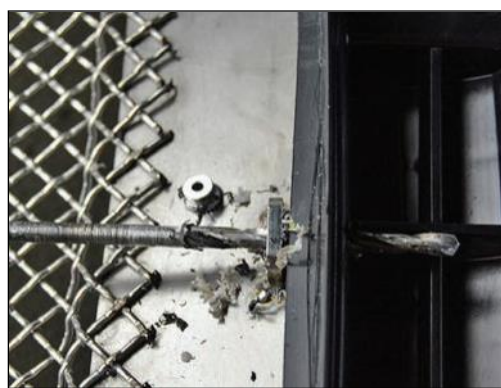
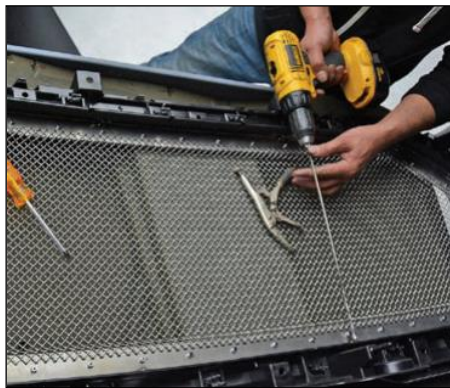
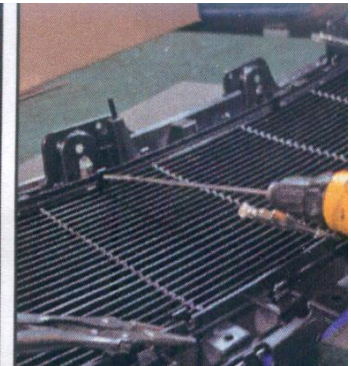

21

Insert provided #8 Screws into each hole drilled.

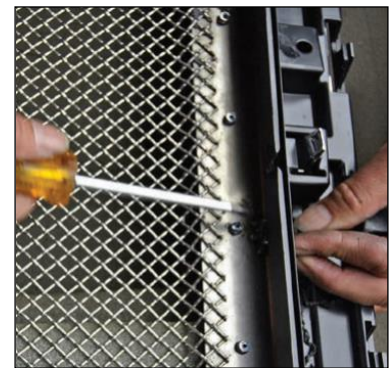
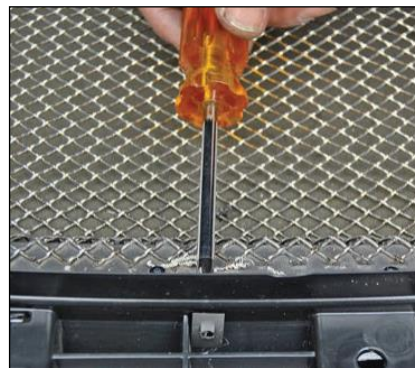

The instruction here is for your reference only. You may need to bend the grille a little bit to adjust to fit. We strongly recommend the professional installer for best result. We are not responsible for any damage caused by the installation. Thank you for choosing our product!

Part#	GR07HFC62T/U	Application	For 2016-2018 GMC Sierra 1500
22	Slide on flat nut and tighten down.		
23	Once satisfied with the grille insert installation, proceed with grille re-assembly.		
24	Take the radiator induction shroud that was set aside earlier and align it over your new grille assembly. Line up the tabs and set it down in place.		
24	Use the plastic push tabs to secure and fasten down.		
26	Take the complete grille assembly, put into place and position to nose of vehicle.		
27	Starting at the top, slip the grille assembly (shell) mounting tabs up and onto their mounts. Note the "Male Post" and "Female Insert" will help locate the correct position of grille assembly.		
28	Position lower mounts and finally re-install all factory hardware.		

The instruction here is for your reference only. You may need to bend the grille a little bit to adjust to fit. We strongly recommend the professional installer for best result. We are not responsible for any damage caused by the installation. Thank you for choosing our product!

Part#	GR07HFC62T/U	Application	For 2016-2018 GMC Sierra 1500
-------	--------------	-------------	--------------------------------------



29	Re-install lower bumper valance.	
----	----------------------------------	--

30	Carefully slip valance into place underneath headlights. Give it a firm press to get everything into position. Fit Valance up and mate it to front fender and finally slip fender trim back over each piece so it all fits nice and tight.	
----	--	--

31	Put Core Support Cover back into place and fasten down with plastic push tabs that were removed prior. Re-Install all hardware that was removed in step #4.	
----	---	--

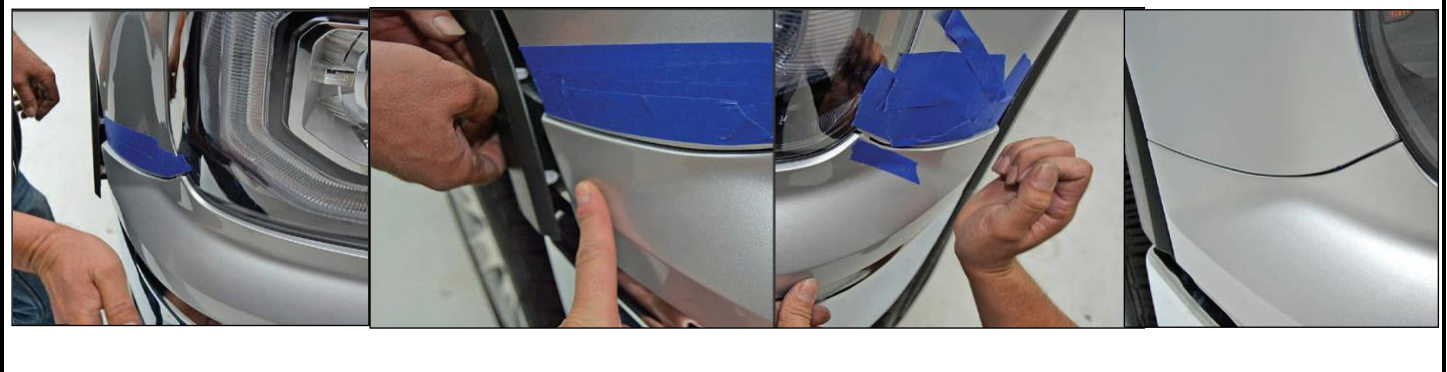

The instruction here is for your reference only. You may need to bend the grille a little bit to adjust to fit. We strongly recommend the professional installer for best result. We are not responsible for any damage caused by the installation. Thank you for choosing our product!

Part#	GR07HFC62T/U	Application	For 2016-2018 GMC Sierra 1500
-------	--------------	-------------	--------------------------------------



32	Check over your work for hardware tightness and visual inspection.
33	At this point you want to look over your work and examine the gap alignments around all edges and in between the new Grille and the vehicle components and body lines. Carefully close the hood for a complete visual inspection. If adjustment is needed, you can remove grille and loosen the hardware mounts and shift side to side or up & down to achieve proper look.
34	Installation completed!!!

The instruction here is for your reference only. You may need to bend the grille a little bit to adjust to fit. We strongly recommend the professional installer for best result. We are not responsible for any damage caused by the installation. Thank you for choosing our product!