

Part#	GR04HEC74C/S/J	Application	For 2002-2005 Dodge Ram		
--------------	----------------	--------------------	--------------------------------	--	--

Parts List	Item	Part Name	QTY	Description	Item	Part Name	QTY	Description
	1	Billet Grille	2	Stainless steel	5	Hex Bolts	4	1/4" -20×3/4"
	2	L shape Tabs	2		6	Truss Head Screws	4	8-32×3/4"
	3	J shape Tabs	2		7	Kep Nuts	4	8-32
	4	Kept Nuts	4	1/4" -20	8	Washers	4	8#

Install Notes: Overlay Replacement Drill Cut

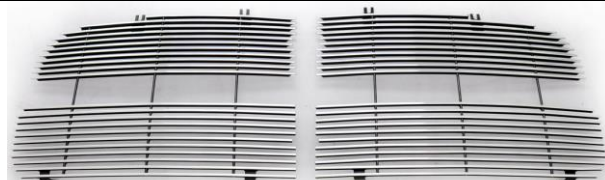

Step	Description	illustration
1	Identify the grille & hardware with parts list.	
2	Pop hood, remove the black plastic cover (on top of OEM grille / front panel) from vehicle. This will allow access to the rear of the grille shell.	
3	Remove the grille shell bracket bolts from the under side of the hood.(Fig 1).	
4	Unclip the hood latch rod.(Fig 2).	
5	Remove factory grille shell from vehicle.(Fig 3).	



6	Remove plastic rivets that hold the factory grille center in place.(Fig 4).
7	Remove factory grille center from the grille shell.(Fig 5).
8	Factory grille shell with the centers removed. (Fig 6).

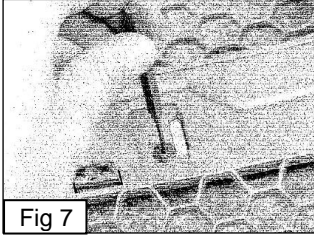
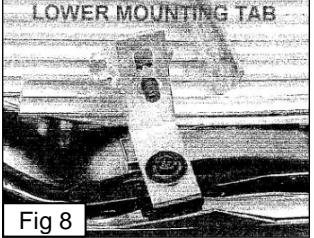
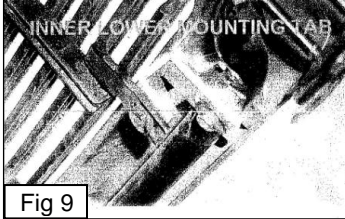
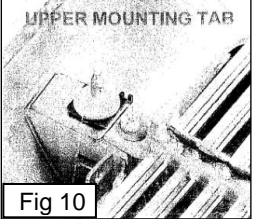
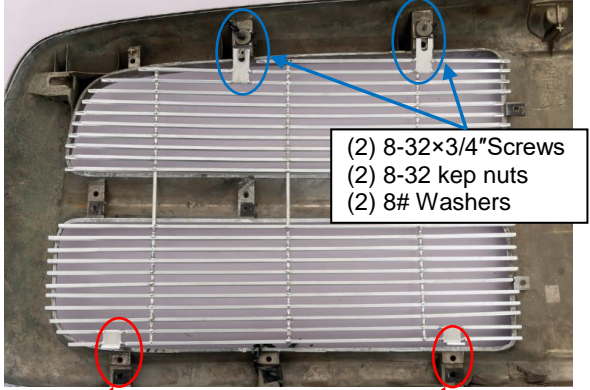

The instruction here is for your reference only. You may need to bend the grille a little bit to adjust to fit. We strongly recommend the professional installer for best result. We are not responsible for any damage caused by the installation. Thank you for choosing our product!

Part#	GR04HEC74C/S/J	Application	For 2002-2005 Dodge Ram
Step	Description	illustration	
9	Place grille shell face down on a soft surface. Knock out rivets holding factory grilles with a 3/32" punch. Lift factory grille out. (Fig 7).	 	
10	Set billet grilles in place. Unscrew 4 bolts from tubular frame near lower mounting tabs only. Attach 2 L shape tabs loosely to lower out mounting tabs, slotted side up with 1/4 X 3/4" bolts and 1/4" kep nuts. (Fig 8).	 	
11	Attach 2 J shape tabs to inner lower mounting tabs. Attach L and J tabs loosely to tubular frame with previously removed bolts. Bend tabs as necessary to fit. (Fig 9).	 <div style="display: flex; justify-content: space-around; margin-top: 10px;"> <div style="border: 1px solid black; padding: 5px; width: 45%;"> <p>(1) L shape tabs (1) 1/4"-20 X 3/4" hex bolts (1) 1/4"-20 kep nuts</p> </div> <div style="border: 1px solid black; padding: 5px; width: 45%;"> <p>(1) 1/4"-20 X 3/4" hex bolts (1) 1/4"-20 kep nuts (1) J shape tabs</p> </div> </div>	
12	Attach upper mounting tabs to grille shell with #8X3/4" screws, #8 washers, and #8 keps nuts through holes just below mounting studs. Center billet grille and tighten all fasteners. (Fig 10).		
13	Reinstall factory grille shell to vehicle .		
14	Installation completed!!!		

The instruction here is for your reference only. You may need to bend the grille a little bit to adjust to fit. We strongly recommend the professional installer for best result. We are not responsible for any damage caused by the installation. Thank you for choosing our product!